



# **MINUTE MAN<sup>®</sup>**

## **Power Technologies**

*From Para Systems, Inc.*

---

### **ED1000T & ED1020T**

Parallel Redundant  
**ON-LINE SERIES**

---

### **User's Manual**

**Para Systems, Inc.**  
1455 LeMay Drive  
Carrollton, TX 75007  
Phone: 1-972-446-7363  
Fax: 1-972-446-9011  
Internet: [minutemanups.com](http://minutemanups.com)  
UPS Sizing: [sizemyups.com](http://sizemyups.com)

PN – 34000356 R3

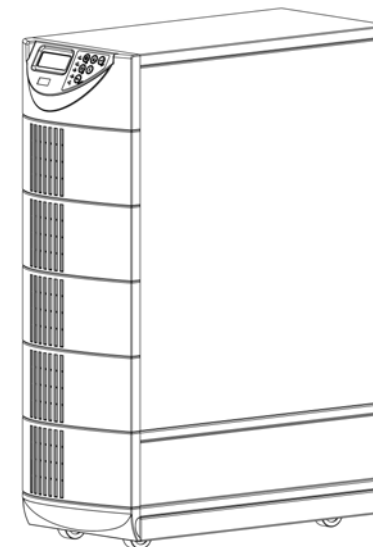

# Table of Contents

<b>1 Important Safety Instructions</b> .....	<b>2</b>
1.1 An Important Notice.....	2
1.2 Life Support Policy .....	3
1.3 FCC Notice.....	3
<b>2 Product Introduction</b> .....	<b>4</b>
2.1 System Overview.....	4
2.2 General Characteristics.....	4
2.3 Symbols on the LCD Display Panel .....	5
2.4 Controls and Indicators .....	9
2.5 Rear Panels.....	10
<b>3 Installation and Operation</b> .....	<b>11</b>
3.1 Unpacking .....	11
3.2 Installation Placement .....	12
3.3 Storage instruction .....	12
3.4 Installation of the Castor Covers .....	13
3.5 Wiring the Input and Output Connections .....	14
3.6 Operation and Setup Instructions.....	19
<b>4 Communication Port, EPO Port and Option Cards</b> .....	<b>30</b>
4.1 RS232 Communication Port.....	30
4.2 EPO Port .....	30
4.3 Option Cards .....	31
<b>5 Power Monitoring Software</b> .....	<b>31</b>
5.1 Hardware Installation.....	31
5.2 Software Installation .....	31
<b>6 Troubleshooting Guide</b> .....	<b>32</b>
<b>7 Replacing the Batteries</b> .....	<b>33</b>
7.1 Battery Replacement Procedure .....	34
<b>8 Specifications</b> .....	<b>38</b>
<b>9 Obtaining Service</b> .....	<b>40</b>
<b>10 Limited Product Warranty</b> .....	<b>41</b>
<b>11 Declaration of Conformity</b> .....	<b>42</b>

© Copyright 2008

# 1 Important Safety Instruction

## 1.1. An Important Notice

- 1.1.1 To ensure safety in all applications where a UPS system is hardwired to the electrical supply the UPS must be installed by a Qualified Electrical Contractor.
- 1.1.2 The UPS has its own internal energy source (battery). If the UPS is switched on when there is no AC power is available, there could be voltage at the output terminals.
- 1.1.3 Servicing of the UPS system must be performed by **Qualified Service Personnel ONLY**. MINUTEMAN accepts no liabilities and is not limited to: injury to the Service Personnel, or damages to; the UPS system, or the connected equipment caused by the incorrect installation or servicing of the UPS system.
- 1.1.4 Make sure that the input voltage rating of the UPS matches the supply voltage.
- 1.1.5 This UPS series is intended to be install in a temperature controlled environment that is free of conductive contaminants. Select a location that will provide good air circulation for the UPS at all times. Avoid locations near heating devices, water or excessive humidity, or where the UPS is exposed to direct sunlight. Route power cords so they cannot be walked on or damaged.
- 1.1.6 To eliminate overheating of the UPS, keep all ventilation openings free from obstruction, and do not store anything on top of the UPS system. Keep the UPS system at least 12" (30 cm) away from the wall.
- 1.1.7 The battery will discharge naturally if the UPS is unused for any length of time. The batteries should be recharged every 2-3 months if unused.
- 1.1.8 This UPS supports electronic equipment in offices, telecommunications, process control, and medical applications.
- 1.1.9 Risk of Electrical Shock. Make sure the UPS is completely turned off when moving the UPS from one location to another.
- 1.1.10 The UPS has a Maintenance Bypass Switch. Follow the procedures to perform the maintenance bypass operation.

- 1.1.11 **SAVE THESE INSTRUCTIONS** - This manual contains important instructions that should be followed during the Installation and the Maintenance of the UPS and batteries.
- 1.1.12 **CAUTION** - A disconnect switch must be provided by the user for the AC output circuit when the UPS's output is hardwired. To reduce the risk of fire, connect only to a circuit provided with branch circuit over-current protection (50 amperes for 208/240V output or 90 amperes for single 120V output) in accordance with the National Electric Code, ANSI/NFPA 70.
- 1.1.13 **CAUTION** - To reduce the risk of fire, connect the input to a circuit provided with branch circuit over-current protection for 50 amperes in accordance with the National Electric Code, ANSI/NFPA 70. Use No. 6 AWG, 60°C copper wire and 22.1lb-in Torque force when connecting to terminal block.
- 1.1.14 **CAUTION** - To reduce the risk of electrical shock with the installation of this UPS system and the connected equipment, the installer must ensure that the combined sum of the AC leakage current does not exceed 3.5mA.
- 1.1.15 **WARNING** - This Uninterruptible Power Supply (UPS) contains potentially hazardous voltages. Do not attempt to disassemble the UPS system beyond the battery replacement procedure. This UPS system contains no user serviceable parts. **QUALIFIED SERVICE PERSONNEL ONLY** must perform the maintenance and the battery replacement for this UPS system.

## 1.2. Life Support Policy

As a general policy, we do not recommend the use of any of our products in life support applications where failure or malfunction of the product can be reasonably expected to cause failure of the life support device or to significantly affect its safety or effectiveness. We do not recommend the use of any of our products in direct patient care. We will not knowingly sell our products for use in such applications unless it receives in writing assurances satisfactory to us that (a) the risks of injury or damage have been minimized, (b) the customer assumes all such risks, and (c) our liability is adequately protected under the circumstances.

## 1.3. FCC Notice

This equipment has been tested and found to comply with the limits for a Class A computing device in accordance with the specifications in Subpart J of Part 15 of FCC Rules and the Class A limits for radio noise emissions from digital apparatus set out in the Radio Interference of the Canadian Department of Communications.

## 2 Product Introduction

### 2.1. System Overview

This On-Line UPS protects computers, servers, internetworking, and telecommunications equipment from blackouts, brownouts, overvoltages, and surges. This On-Line UPS converts the input AC to DC and then back to a True Sine Wave AC output. The True Sine Wave output is regulated within 2% of the nominal output voltage. The Power Factor Correction (PFC) circuitry corrects the input power factor to within 98% of unity and blocks the load generated harmonic distortion from getting back on the input AC line. This On-Line UPS provides a continuous true sine wave output with zero transfer time and great regulation to protect your mission critical equipment. The UPS will quietly and confidently protect your system from power anomalies.

### 2.2. General Characteristics

2.2.1 True On-Line architecture continuously supplies your critical equipment with a stable, regulated, transient-free, pure sine wave AC Output Power.

2.2.2 The multi-functional LCD/LED panel will display various states of the UPS. The LED display will show the UPS working status, Utility Status and UPS Abnormal status. The LCD display will show the Input/Output voltage, frequency, load status, internal temperature, and faults.

2.2.3 The digital control circuit enhances the ability of the UPS for remote control and monitoring.

2.2.4 These UPS systems can be used in a Parallel Redundant application. To operate these UPS systems in the Parallel Redundant mode requires the Parallel Redundant kit. Contact your local distributor for more information concerning the Parallel Redundant operation.

2.2.5 Maintenance Bypass Switch — which reduces down time for maintenance.









2.2.6 The DC-start function allows the start-up of UPS when there is no utility power available.







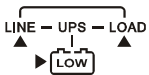



2.2.7 This UPS system has the Independent Battery Bypass function. The Independent Battery Bypass function allows the UPS system to provide a stable, regulated, transient-free pure sine wave AC output power even when the batteries are weak or dead.

2.2.8 The battery management circuit analyses the battery discharging status to adjust the battery cut-off point and extend the life of batteries.

2.2.9 The temperature-controlled fans will extend the life of the fans and reduce the annoying noise caused by fans.

### 2.3. Symbols on the LCD Display Panel

Item	Symbol	Description
1	LINE	Utility or Bypass Source
2		Battery Low
3		Battery Abnormal
4		Output Overload
5		UPS working in specified mode
6		A Blackout Transfer occurred in UPS Output
7		Bypass Input Abnormal, UPS fails to transfer to Bypass, Bypass Abnormal at ECO mode
8		Utility Input Abnormal
9	OFF	UPS Shutoff
10	BPS	Bypass Mode
11	LINE OFF	UPS Abnormal Lock
12		UPS Flow Chart
13		4 Digits Measurement Display
14		Indicate the item desired to be measured

15		ON and Alarm Silencer Switch
16		OFF Switch
17		Previous Page or Setting Change
18		Next Page
19		Special Function Log in /out
20		Enter or Reconfirmed
21		Utility Input Normal LED
22		Bypass Input Normal LED
23		UPS under Redundancy Mode
24		UPS under ECO Mode
25		UPS Fault or Abnormal Warning LED
26	<b>EPO</b>	Emergency Power Off
27	<b>Er01</b>	DC BUS capacitor pre-charge abnormal after 50-seconds or Battery Fuse failure
28	<b>Er02</b>	AC SCR or Battery SCR soft Start abnormal after 2-seconds
29	<b>Er03</b>	PFC (Boost) soft start abnormal after 30-seconds
30	<b>Er04</b>	Inverter Failure
31	<b>Er05</b>	Battery Weak or Dead

32	<b>Er06</b>	Output Short Circuit
33	<b>Er08</b>	DC Bus high-voltage-level abnormal
34	<b>Er09</b>	DC Bus low-voltage-level abnormal
35	<b>Er10</b>	Inverter Over-current
36	<b>Er11</b>	UPS Overheated
37	<b>Er12</b>	Inverter Overload
38	<b>Er13</b>	Charger Failure or Abnormal
39	<b>Er14</b>	Fan Failure
40	<b>Er15</b>	Wrong procedure to enter Maintenance Mode
41	<b>Er16</b>	Output parameters Set error in Parallel System
42	<b>Er17</b>	ID numbers are in conflict in Parallel System or ID number error in single unit
43	<b>Er18</b>	EEPROM data error. Its values are reset to default (Normal / 220V / adj0% / +/-3Hz / low sensitivity)
44	<b>Er20</b>	DC Bus voltage cannot be discharged
45	<b>Er21</b>	Parallel communication error (communication wire disconnected or failure to find ID1 UPS) in parallel system
46	<b>Er22</b>	Bypass SCR or Output Fuse Fails
47	<b>Er23</b>	Inverter Relay or SCR or Output Fuse Fails

48	<b>Er24</b>	Bypass Input found when running on CVCF mode ( <b>CVCF mode not supported</b> )
49	<b>Er26</b>	PFC Over-current
50	<b>Er27</b>	The UPS must be operated in normal mode in parallel system
51	<b>Er28</b>	Bypass Overload Time out and cut off output.
52	<b>Er29</b>	Charger overcharges battery (>300Vdc)
53	<b>Er30</b>	Inverter Balance error
54	<b>Er31</b>	The settings of both control board and driver board are not matched together
55	<b>Er32</b>	Sync Signal error
56	<b>Er33</b>	Isolated transformer overheat
57	<b>Er34</b>	Balance function conflict
58	<b>CEr1</b>	Utility voltage out of range
59	<b>CEr2</b>	Bypass Voltage out of range
60	<b>CEr3</b>	Inverter Voltage out of range
61	<b>CEr4</b>	Load Percentage out of range
62	<b>CEr5</b>	Battery Voltage out of range
63	<b>CEr6</b>	UPS Output Voltage out of range

(\*\* Er7, Er19, Er25 are reserved)

## 2.4. Controls and Indicators

### 2.4.1 UPS Control panel

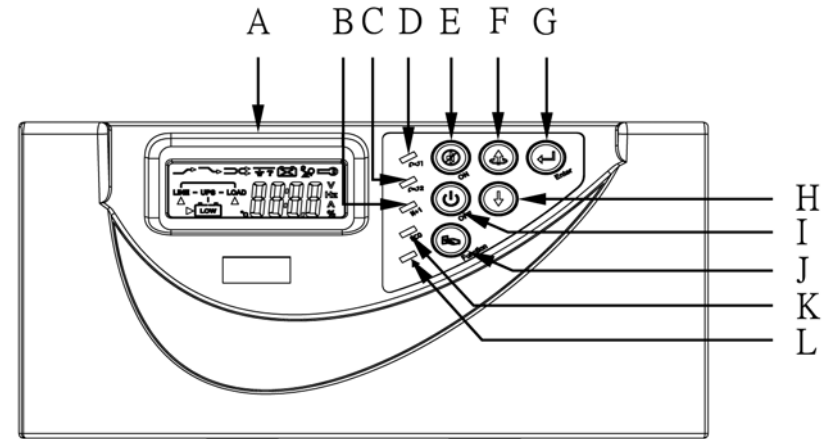

- A LCD Display.
- B N+1 (green) LED illuminates when the UPS is operating in the Parallel/Redundant mode.
- C Bypass (green) LED illuminates when the bypass input is normal. The LED extinguishes in the Battery mode.
- D Line (green) LED illuminates when the utility input voltage is within the acceptable window. The LED extinguishes in the Battery mode.
- E On/Alarm Silencer switch is to turn the UPS On or silence the audible alarm in the Battery mode.
- F Up arrow: Go to previous page or change the UPS setting.
- G Enter key: To save the changes to the UPS setting.
- H Down arrow: Go to next page.
- I OFF switch is to turn the inverter off and transfers the UPS to the Bypass mode.
- J Special functions key: Log in/out.
- K ECO (yellow) LED illuminates when the UPS is working in the ECO (economic, Line-interactive) mode.
- L Fault (red) LED illuminates when there is an abnormal condition or there is an internal fault.

## 2.5. Rear Panel

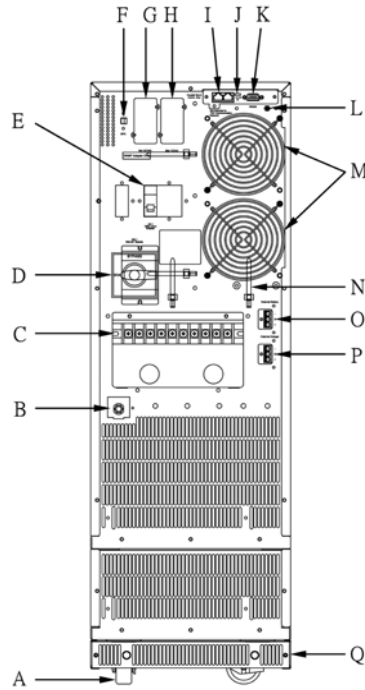

- A Casters.
- B Thermal Circuit Breaker (CB3) for output isolation transformer protection (Only on model ED1000T)
- C Terminal Block for Input/Output Connections.
- D Maintenance Bypass Switch.
- E Input Circuit Breaker.
- F EPO (Emergency Power Off) Port.
- G Option Slot 2 is for the SNMP card and the Programmable Relay card only.
- H Option Slot 1 is for other option cards except the SNMP card and the Programmable Relay card.
- I Connectors for Maintenance Bypass and Parallel Redundant function.
- J Dipswitch for the Parallel Redundant function.  
**NOTE:** The dipswitch must be in the Off position when the Parallel function is not being used.
- K RS232 Port for monitoring and control.
- L Dipswitch for FACTORY USE ONLY.
- M Cooling fans.
- N Cable tie downs.
- O Battery Connector for connecting an External Battery Pack.
- P Battery Connector for Daisy Chaining an additional External Battery Pack or for connecting an External Charger.
- Q Caster cover plate.

## 3 Installation and Operation

### (QUALIFIED SERVICE PERSONNEL ONLY)

Be sure to read the Installation Placement and all of the **CAUTIONS** and the **WARNINGS** before installing the UPS system. Packages that are crushed, punctured, or torn such that the contents are revealed should be set-aside in an isolated area and be inspected by a qualified person. If the package is deemed to be not usable, immediately contact the freight carrier and the place of purchase. **USE CAUTION:** This UPS system is extremely heavy. Always use the appropriate number of personnel when handling the UPS system.

### 3.1. Unpacking

- 3.1.1 Cut the banding straps and discard them.
- 3.1.2 Lift the cardboard carton upwards off the packaging crate.
- 3.1.3 Cut the banding strap. Remove the ramp and the corner post. Remove the side blocks. Use a screwdriver to remove the end stop.
- 3.1.4 Place the ramp against the pallet. Remove the metal bracket and insert as shown to secure the ramp to the pallet.
- 3.1.5 Push the unit slowly down the ramp.
- 3.1.6 After removing your UPS from the packaging crate, it should be inspected for damage that may have occurred in shipping. Immediately notify the carrier and place of purchase if any damage is found. The packing materials that your UPS system was shipped in are carefully designed to minimize any shipping damage. In the unlikely case that the UPS system needs to be returned to the manufacturer, please use the original packing material. Since the manufacturer is not responsible for shipping damage incurred when the system is returned, the original packing material is inexpensive insurance.

**PLEASE SAVE THE PACKING MATERIALS!**

#### Unpacking Instructions

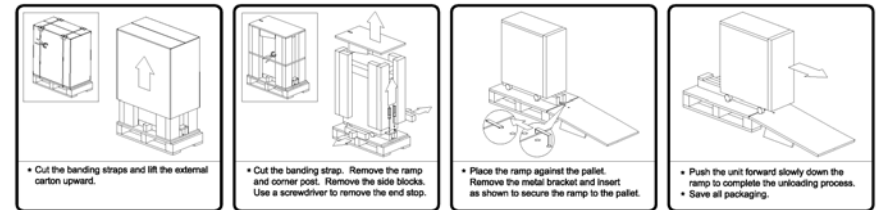

- 3.1.7 Standard Package includes:

- User's Manual
- Warranty and Platinum Protection documents
- Power Monitoring software CD with RS232 cable
- One set of Accessories

### 3.2. Installation Placement

This UPS system is intended to be install in a temperature controlled environment that is free of conductive contaminants. Select a location, which will provide good air circulation for the UPS at all times. Keep at least 12 inches (30cm) clearance from the rear panel of the UPS to the wall. Avoid locations near heating devices, water or excessive humidity, or where the UPS is exposed to direct sunlight. Route power cords so they cannot be walked on or damaged.

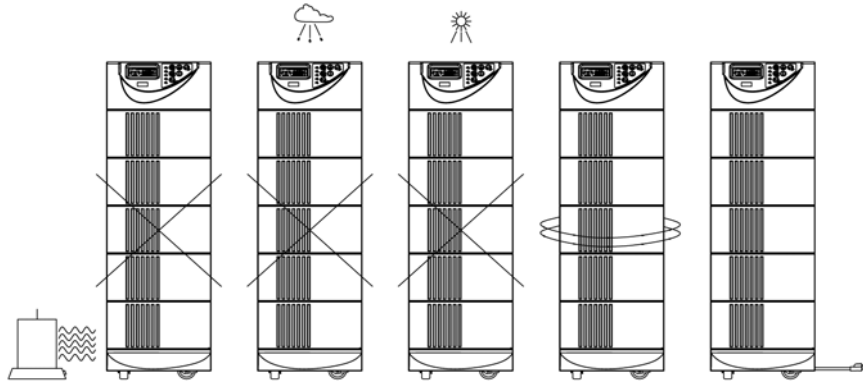

ENVIRONMENTAL	
Operating Temp (max)	0 to 40°C (+32 to +104°F) ≤2000m (≤+6700 ft) 0 to 35°C (+32 to +95°F) at 3000m (+10,000 ft)
Storage Temp	-15 to +45°C (+5 to +113°F)
Operating/Storage Humidity	30 - 90% Non-Condensing
Storage Elevation	0 to 15,000m (0 to +50,000 ft)

### 3.3. Storage Instruction

For extended storage with moderate climates, the batteries should be charged for 12-hours every 3 months. Repeat this procedure every 2 months under high temperature environments.

### 3.4. Installation of the Caster Covers

- 3.4.1 Lock the casters so that the unit will not move.
- 3.4.2 Step 1: There are two A1 cover plates, one for each side of the unit. Insert the A1 cover plates into the slots and slide towards the rear of the unit.
- 3.4.3 Step 2: There are two A2 cover plates, one for the front of the unit and one for the rear of the unit. Insert the A2 cover plates into the slots and push downwards toward the floor.
- 3.4.4 Step 3: There are four retaining screws S1. Install the S1 retaining screws into the A2 cover plates.
- 3.4.5 Step 4: There is one A3 cover plate. Insert the A3 cover plate into the holes on the A2 cover plate on the front of the unit and press firmly.

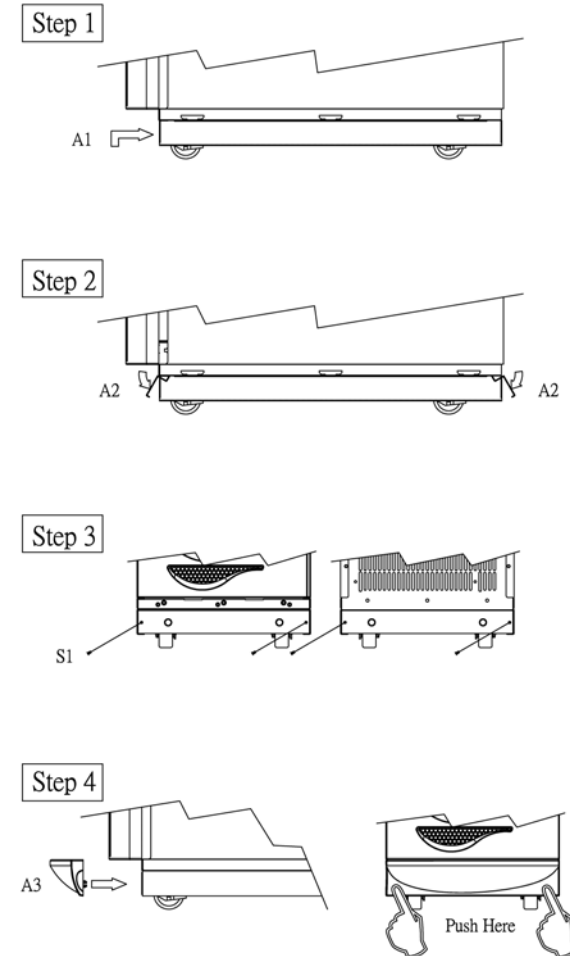



### 3.5. Wiring the Input and Output Connections (Qualified Electrical Contractor Only)

3.5.1 **A Qualified Electrical Contractor must perform the hardwiring** when connecting the Input and Output wires to the terminal block on the ED10000T UPS. Apply 22.1lb-in of torque force when connecting to the terminal blocks. The Input and Output of the UPS MUST be Hardwired.

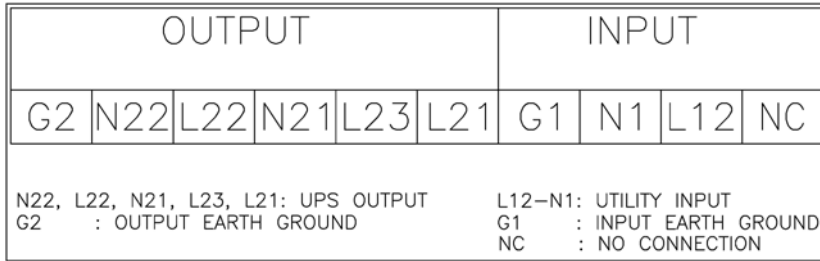

3.5.1.1 INPUT connections for the ED10000T Hardwired only:

1. Connect L1 from the utility to terminal L12.
2. Connect L2 from the utility to terminal N1.
3. Connect the earth ground from the utility to terminal G1.

**CAUTION** - To reduce the risk of fire, connect the UPS Utility input to a branch circuit with an over-current protection of 50 amperes in accordance with the National Electric Code, ANSI/NFPA 70. Use No. 6 AWG, 60°C copper wire and apply 22.1lb-in of torque force when connecting to the terminal blocks.

3.5.1.1.1 OUTPUT connections for ED10000T Hardwired only:

Configurations #1 – #7 are for Hardwiring the output of ED10000T. **A Qualified Electrical Contractor must perform the hardwiring.** The outputs must be connected to an over-current protection device (circuit breaker) in accordance with the National Electric Code, ANSI/NFPA 70. Use 60°C copper wire and apply 22.1lb-in of torque force when connecting to the terminal blocks.

Output Voltage and Load	Output Circuit Breaker	Wire
208V & 240V / 10KVA	50 Amps	6 AWG
120V / 5KVA	45 Amps	6 AWG
120V / 10KVA	90 Amps	3 AWG

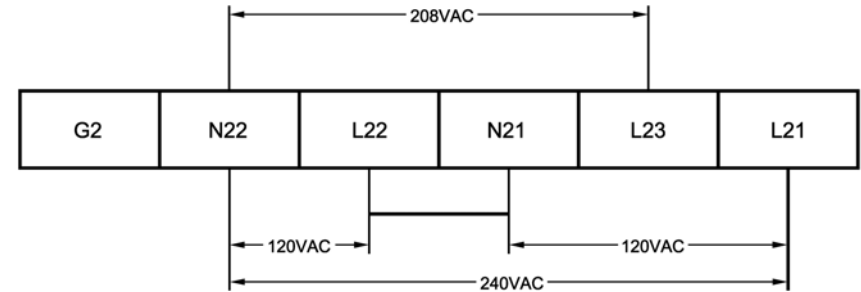

3.5.1.1.2 Configuration # 1:

Output: Two 120VAC 5KVA circuits (5KVA max load per circuit). Total combined output load not to exceed 10KVA.

1. Circuit1 (120VAC): L22 - Line, N22 - Neutral, G2 - Ground.
2. Circuit2 (120VAC): L21 - Line, N21 - Neutral, G2 - Ground.

OUTPUT CONFIGURATION #1 = 120VAC / 120VAC

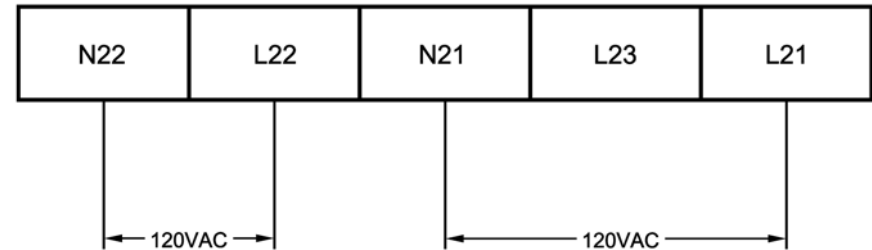

3.5.1.1.3 Configuration # 2:

Output: One 120VAC 10KVA circuit. Total output load not to exceed 10KVA.

1. Connect a jumper wire from L22 to L21.
2. Connect a second jumper wire from N22 to N21.
3. Circuit1 (120VAC): L22 - Line, N22 - Neutral, G2 - Ground.

OUTPUT CONFIGURATION #2 = 120VAC

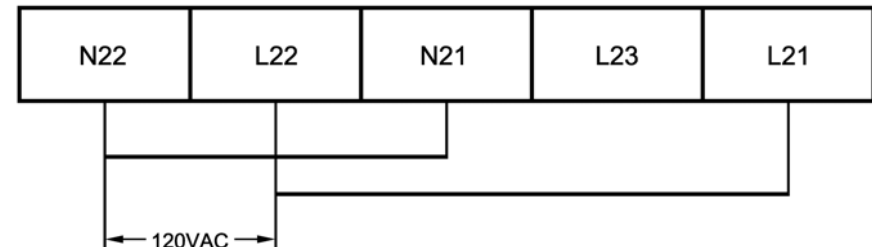

3.5.1.1.4 Configuration # 3:

Output: One 208VAC 10KVA circuit. Total output load not to exceed 10KVA.

1. Connect a jumper wire from L22 to N21.
2. Circuit1 (208VAC): L23 - L1, N22 - L2, G2 - Ground.

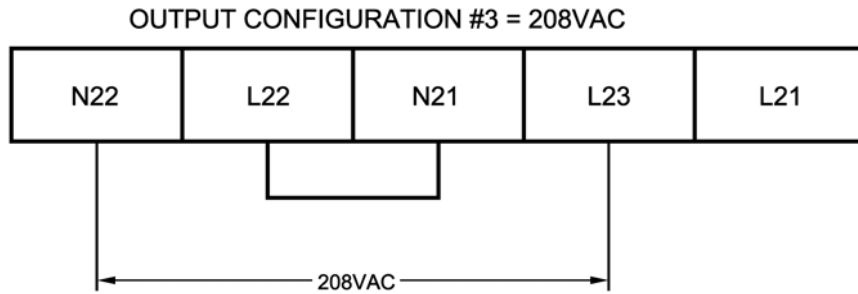

3.5.1.1.5 Configuration # 4:

Output: One 240VAC 10KVA circuit. Total output load not to exceed 10KVA.

1. Connect a jumper wire from L22 to N21.
2. Circuit1 (240VAC): L21 - L1, N22 - L2, G2 - Ground.

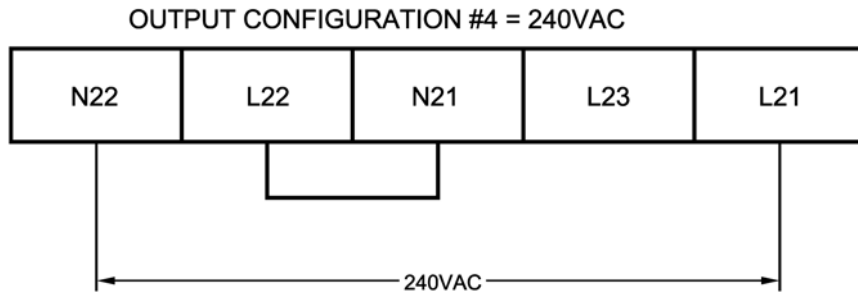

3.5.1.1.6 Configuration # 5:

Output: Two 120VAC circuits (5KVA max load per circuit), and one 208VAC 10KVA circuit. Total combined output load not to exceed 10KVA.

1. Connect a jumper wire from L22 to N21.
2. Circuit1 (120VAC): L22 - Line, N22 - Neutral, G2 - Ground.
3. Circuit2 (120VAC): L21 - Line, N21 - Neutral, G2 - Ground.
4. Circuit3 (208VAC): L23 - L1, N22 - L2, G2 - Ground.

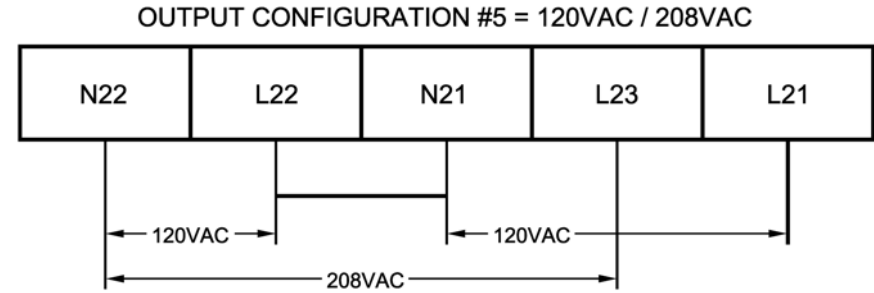

3.5.1.1.7 Configuration #6:

Output: Two 120VAC circuits (5KVA max load per circuit) and one 240VAC 10KVA circuit. Total combined output load not to exceed 10KVA.

1. Connect a jumper wire from L22 to N21.
2. Circuit1 (120VAC): L22 - Line, N22 - Neutral, G2 - Ground.
3. Circuit2 (120VAC): L21 - Line, N21 - Neutral, G2 - Ground.
4. Circuit3 (240VAC): L21 - L1, N22 - L2, G2 - Ground.

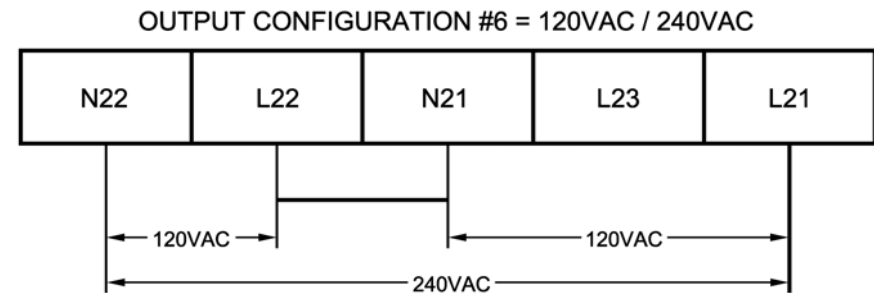

3.5.2 **A Qualified Electrical Contractor must perform the hardwiring** when connecting the Input and Output wires to the terminal block on the ED10200T UPS. Apply 22.1lb-in of torque force when connecting to the terminal blocks. The Input and Output of the UPS MUST be Hardwired.

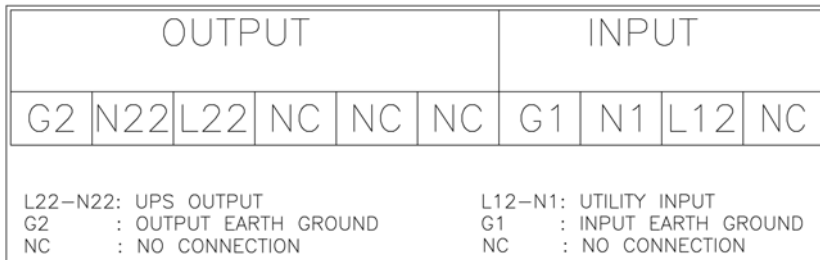

3.5.2.1 INPUT connections for the ED10200T Hardwired only:

1. Connect L1 from the utility to terminal L12.
2. Connect L2 from the utility to terminal N1.
3. Connect the earth ground from the utility to terminal G1.

**CAUTION** - To reduce the risk of fire, connect the UPS Utility input to a branch circuit with an over-current protection of 50 amperes in accordance with the National Electric Code, ANSI/NFPA 70. Use No. 6 AWG, 60°C copper wire and apply 22.1lb-in of torque force when connecting to the terminal blocks.

3.5.2.1.1 OUTPUT connections for ED10200T Hardwired only:

1. Connect L1 from the load to terminal L22.
2. Connect L2 from the load to terminal N22.
3. Connect the earth ground from the load to terminal G2.

**A Qualified Electrical Contractor must perform the hardwiring.** The outputs must be connected to an over-current protection device (circuit breaker) of 50 amperes in accordance with the National Electric Code, ANSI/NFPA 70. Use No. 6 AWG, 60°C copper wire and apply 22.1lb-in of torque force when connecting to the terminal blocks.

### 3.6. Operation and Setup Instructions

3.6.1 Startup in the Normal Mode

- 3.6.1.1 Switch the Utility power circuit breaker (at the service panel) to the On position.
- 3.6.1.2 Switch the UPS's Input circuit breaker (on the rear panel) to the On position.
- 3.6.1.3 The UPS will startup. The Green LEDs  $\approx 1$  &  $\approx 2$  will illuminate to show the Utility and Bypass Inputs are normal. The LCD display will display drawing A then drawing B.

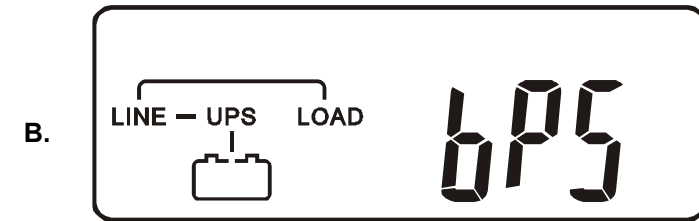
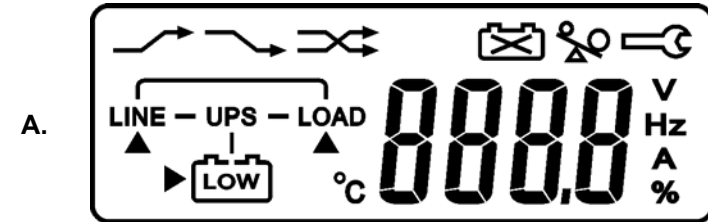

3.6.1.4 The UPS is in Bypass mode. The UPS will automatically perform a self-test. If there are no error codes displayed then the UPS has successfully passed the startup self-test and will start charging the batteries.

3.6.1.5 Press and hold the On Switch (on the front panel)  for approximately 3-seconds, then release. The audible alarm will sound 2-beeps then the LCD display will change from drawing B to drawing C.

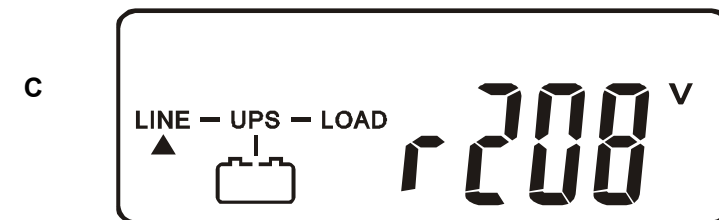

3.6.1.6 The UPS will perform another self-test and the LCD display will change from drawing C to drawing D. During the self-test the UPS will switch to the Battery mode for approximately 4-seconds, then the LCD display will change from drawing D to drawing E1. Once the UPS successfully passes the self-test the LCD will display drawing F. If the UPS fails the self-test the LCD will display drawing E2 then the LCD will display an error code or error status. See Section 2.2 for Error codes and Section 4 for Troubleshooting.

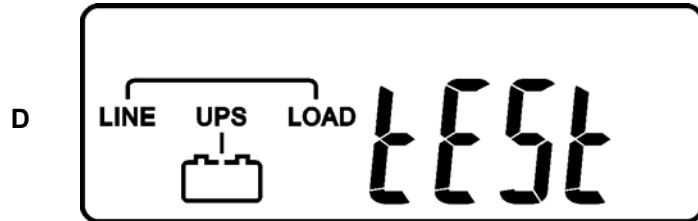

\* It shows "test" during the self-test.

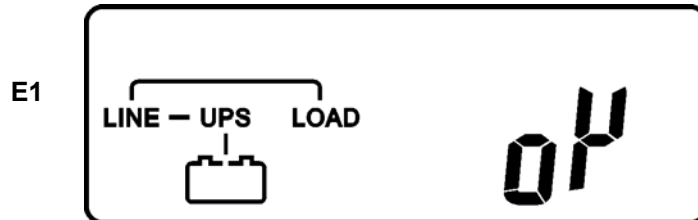

\* It shows "OK" if the self-test was successful.

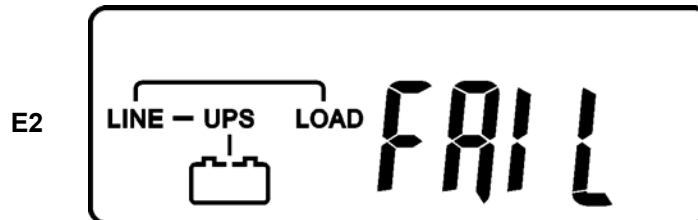

\* It shows "Fail" if the UPS fails the self-test.

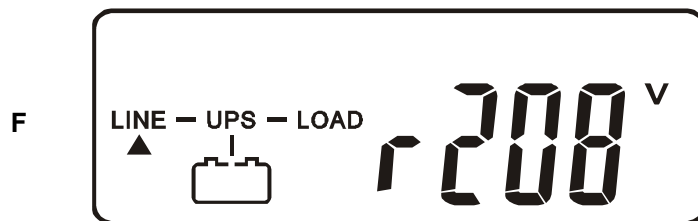



\* It shows "208VAC" Utility Input.

3.6.1.7 The UPS has successfully passed the start-up procedure. The UPS will charge the batteries whenever the UPS is connected to an AC source and there is an acceptable AC voltage present. It is recommended that the UPS's batteries be charged for a minimum of 8-hours before use. However the UPS may be used immediately, but the "On-Battery" runtime maybe less than normally expected. **NOTE:** If the UPS is going to be out of service or stored for a prolonged period of time, the batteries must be recharged for at least 12-hours every 3 months.

### 3.6.2 Startup in Battery Mode (Cold Start)

3.6.2.1 Switch the UPS's input circuit breaker (on the rear panel) to the On position.

3.6.2.2 Press and hold the UPS On Switch (on the front panel)  for approximately 3-seconds, then release, the audible alarm will sound 2-beeps. The LCD display will scroll from drawing A to drawing G this will take approximately 10-seconds.

3.6.2.3 During this 10-seconds press and hold the UPS On Switch again  for approximately 3-seconds, then release, the audible alarm will sound 2-beeps. The LCD display will change from drawing G to drawing H, the UPS will be in self-test mode. The UPS will provide an output within approximately 1-minute, and then the LCD display will display drawing I. If the UPS On switch was not pressed within the 10-seconds, the UPS will automatically turn off. You will have to repeat the above steps again.

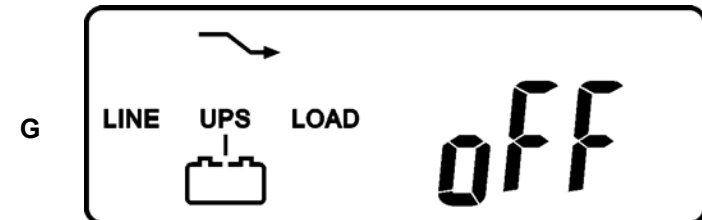

\* It shows "Off", which means the UPS pre-start is successful.

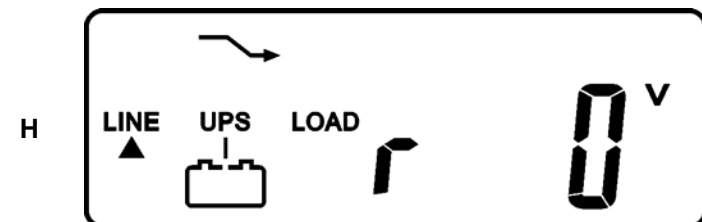

\* It shows the Utility input is "0VAC".

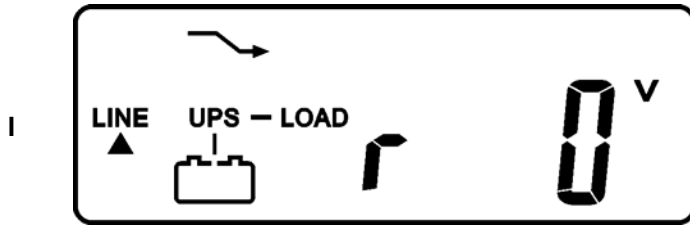

\* It shows the UPS is providing power to the "load".

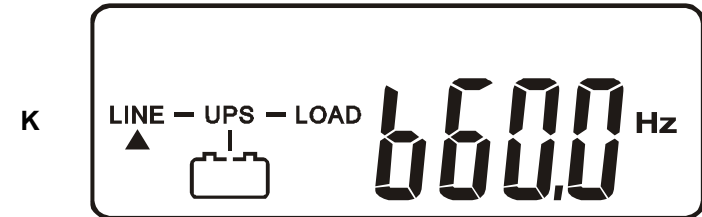

\* It shows the input frequency from the Bypass Input.

### 3.6.3 Measured Values detected by UPS

3.6.3.1 If you would like to check the measured values detected by the UPS, please use the scroll down (↓) and scroll up (↑) keypads. When you use scroll down keypad, the LCD display will display the drawings in the following order:

- Drawing C (Voltage from Utility Input)
- Drawing I1 (Voltage from Bypass Input)
- Drawing J (Frequency from Utility Input)
- Drawing K (Frequency from Bypass Input)
- Drawing L (UPS Output Voltage)
- Drawing M (UPS Output Frequency)
- Drawing N (UPS Output Load %)
- Drawing O (UPS Battery Voltage)
- Drawing P (UPS Internal Temperature)

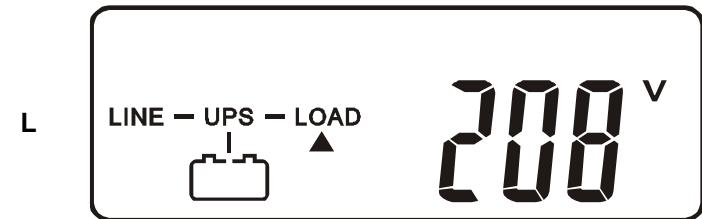

\* It shows the Output Voltage from the Inverter.

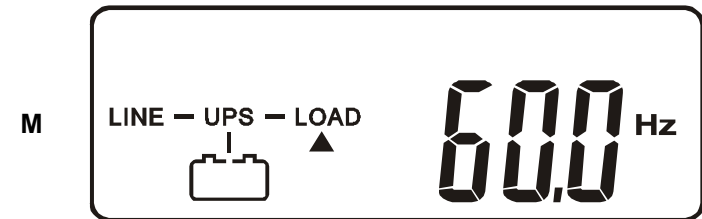

\* It shows the Output Frequency from the Inverter.

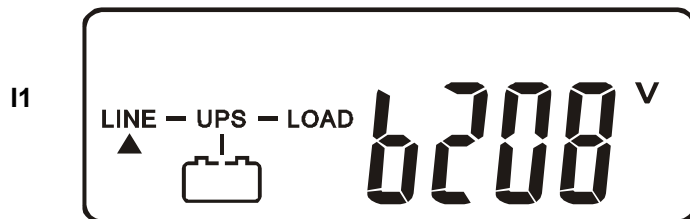

\* It shows the input voltage from the Bypass Input.

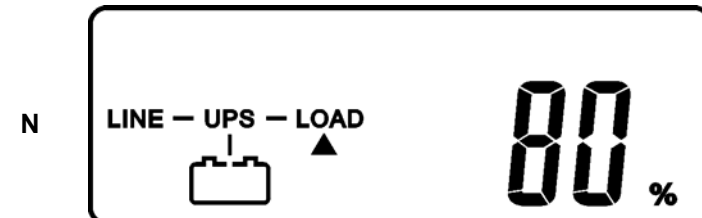

\* It shows the Output Load Level Percentage (%).

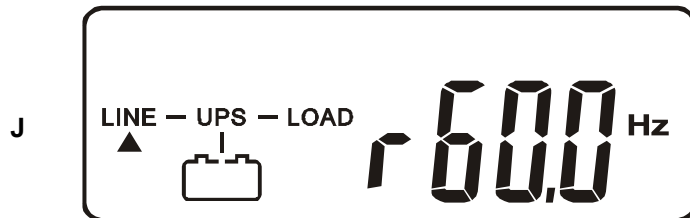

\* It shows the input frequency from the Utility Input.

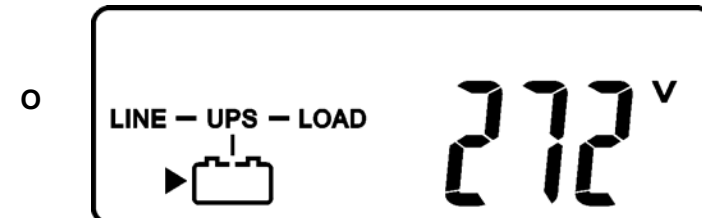

\* It shows the Battery Voltage.

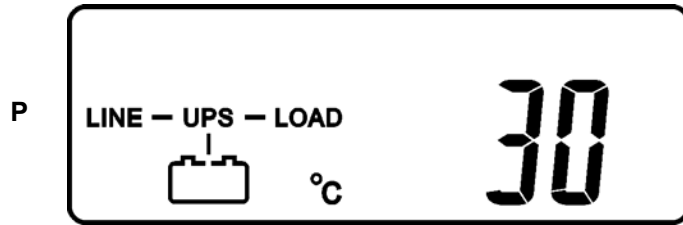

\* It shows the Internal Temperature of the UPS System.

### 3.6.4 UPS Default Data and Special Function Features

3.6.4.1 Once the UPS has successfully started up, press the Special Function keypad to change the LCD display screen to drawing Q1. 

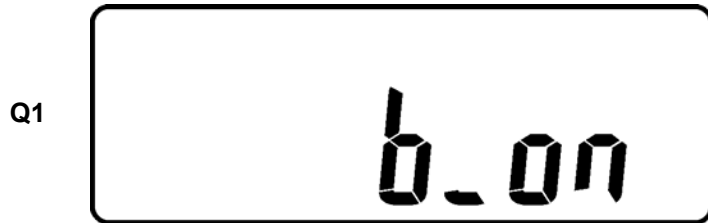

\* It shows the Buzzer is "Enabled".

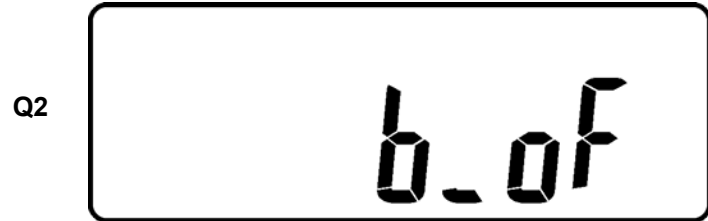

\* It shows the Buzzer is "Disabled".

3.6.4.2 Press the scroll down  keypad to check the UPS settings.

- Drawing Q1 (Buzzer/audible alarm)
- Drawing R1 (Self-test)
- Drawing S1 (Bypass Voltage Window)
- Drawing T (Output Frequency Synchronization Window)
- Drawing U (Inverter Output Voltage)
- Drawing V1 (UPS Operation Mode)
- Drawing W (Output Voltage Fine Tune)
- Drawing X (UPS ID)
- Drawing Y (Number of UPSs in Parallel)

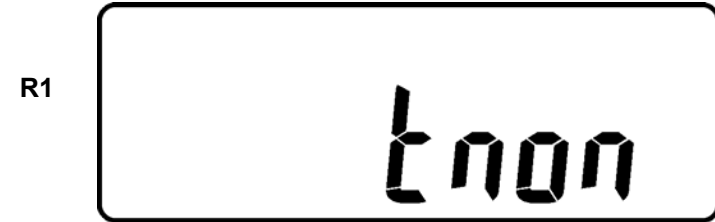

\* It shows the Self-test is "Disabled".

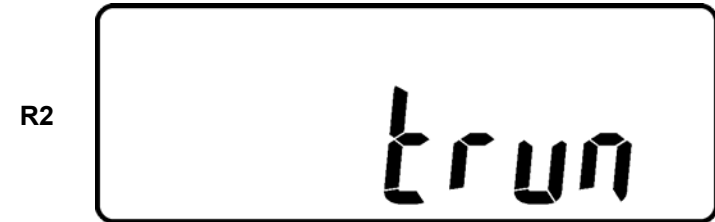

\* It shows the Self-test is "Enabled".

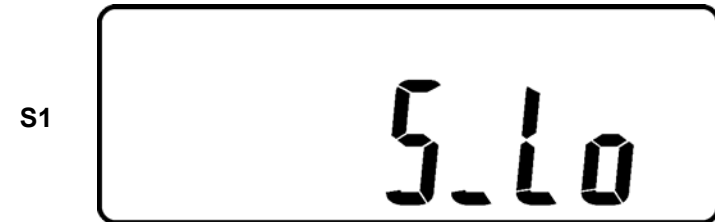

\* It shows the Bypass Voltage is adjusted to the lower limit.

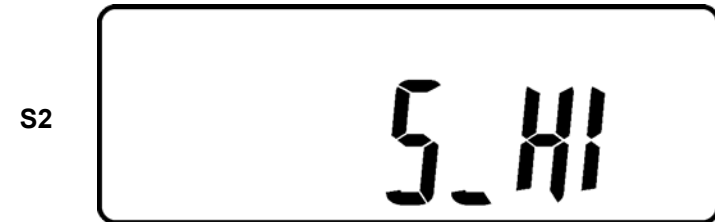

\* It shows the bypass voltage is adjusted to the higher limit.



\* It shows the Frequency Window is +/-3Hz.

U



\* It shows the Inverter Output Voltage setting.

V1



\* It shows the UPS is operated in the "Normal mode".

V2

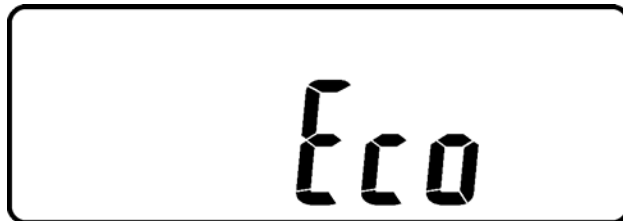

\* It shows the UPS is operated in the "Eco mode".

W



\*It shows the Fine Tune Adjustment % from 0% to 3% or -0% to -3%.

X



\* It shows the UPS Identification Number.

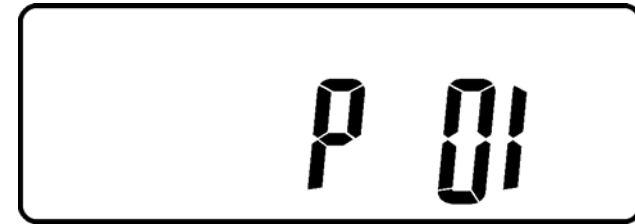

Y



\* It shows that this UPS is the first UPS in the parallel systems.

3.6.4.3 Press the scroll up  keypad to change the default setting. The settings includes Buzzer ON (as drawing Q1), or Buzzer OFF (as drawing Q2, Alarm silence for UPS Warning) and self-test OFF (as drawing R1) or Self-test ON (as drawing R2). The UPS will execute battery test for 10-seconds. If the Self-test is successful, it will show as Drawing E1; otherwise, it will show as drawing E2 and the error message.

### 3.6.5 UPS Default Settings and the Configurable Settings

3.6.5.1 Make sure the UPS is in the Off position. Press and hold the On Switch  and the scroll down  keypads simultaneously for approximately 3-seconds and then release, the audible alarm will sound 2-beeps, the LCD display screen shows as drawing Q1, then the UPS is under setting mode.

3.6.5.2 Except for the Buzzer (as drawing Q1 & Q2) and the Self-test (as drawings R1 & R2), all the rest of the default settings may be changed by pressing scroll up  keypad.

3.6.5.3 Drawings S1 and S2 mean the bypass input window, can be changed to 184VAC~260VAC or 195VAC~260VAC.

3.6.5.4 Drawing T means the bypass frequency window of the Inverter Output can be changed to  $\pm 3\text{Hz}$  or  $\pm 1\text{Hz}$ .



3.6.5.5 Drawing U means the Inverter Output Voltage can be changed to 200VAC, 208VAC, 220VAC, 230VAC, or 240VAC.

3.6.5.6 Drawing V1, V2, V3 and V4 means the operation modes of the UPS can be changed to Online, Eco, fixed 50Hz Output or fixed 60Hz Output modes.

3.6.5.7 Drawing W means the adjustments of the Inverter Output can be fine tuned to 0%, +1%, -1%, +2%, -2%, +3%, or -3%.

3.6.5.8 Drawing X means a specified address and position of the UPS when the UPS is in the Parallel mode. The settable numbers are from 1 to 4.

3.6.5.9 Drawing Y means the total numbers of UPSs in the Parallel mode. The settable numbers are from 1 to 4.

- 3.6.5.10 When all of the setting changes are complete, press the enter  keypad to save all the changes. Then the LCD screen will display drawing Z, then the LCD screen will change to drawing AA to confirm the changes. If you do not want to save the changes press the “OFF”  keypad for 5-seconds, then the LCD screen turns to Drawing AA, which means your changes were not saved.
- 3.6.5.11 Turn Off the input circuit breaker on the rear panel of the UPS module.
- 3.6.5.12 The changes to the Settings are complete.

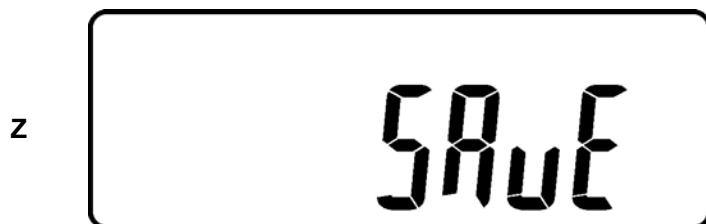





\* Press the Enter keypad to save the data.



\*It shows the UPS is locked.

### 3.6.6 UPS Is Off Due to Unknown Reason



- 3.6.6.1 If a serious abnormal condition occurred, the UPS will lock it itself in the “OFF” position as shown in drawing AA and a error message will be displayed on the LCD screen.
- 3.6.6.2 After 3 seconds, all messages will be locked except the Bypass messages (LED  & LCD  ). If the utility voltage is abnormal after the UPS is locked, the LED  will be extinguished and the LCD  will be shown on the LCD screen.
- 3.6.6.3 Check the error messages then see section 4 to troubleshoot the problem or see section 8 Obtaining Service. To unlock the UPS press the OFF switch  for 5-seconds and the audible alarm will sound 2-beeps. Turn Off the input circuit breaker on the rear panel of the UPS. The UPS will be unlocked now, but the original problem may not be resolved, see section 8 Obtaining Service.

### 3.6.7 Turning Off the UPS

- 3.6.7.1 Press the Off switch  for approximately 5-seconds, the Inverter will turned off, the UPS will transfer to the Bypass mode and the LCD screen will display drawing B.
- 3.6.7.2 Turn Off the input circuit breaker on the rear panel of the UPS.
- 3.6.7.3 Turn Off the DC circuit breaker on the rear panel of the Battery Pack.
- 3.6.7.4 The UPS is OFF.
- 3.6.7.5 To completely de-energize the UPS, disconnect the battery cable from the rear panel of the UPS. Turn Off the utility circuit breaker at the service panel.

### 3.6.8 Maintenance Bypass Procedure

3.6.8.1 The Maintenance Bypass Switch is for the maintenance of the UPS module only. The maintenance of the UPS module must be done by **QUALIFIED SERVICE PERSONNEL ONLY**. MINUTEMAN accepts no liabilities and is not limited to: injury to the Service Personnel, or damages to; the UPS system, or the connected equipment caused by the incorrect servicing of the UPS system.

- 3.6.8.1.1 Press the Off switch  for approximately 5-seconds, the LCD screen will display drawing B and the UPS will be in the Bypass mode.
- 3.6.8.1.2 Remove the Maintenance Bypass Switch cover from the Maintenance Bypass Switch on the rear panel of the UPS.
- 3.6.8.1.3 Turn the Maintenance Bypass Switch to the “Bypass” position. The LCD screen will display the maintenance sign  at the upper right-hand corner of the LCD screen.
- 3.6.8.1.4 Turn off the UPS’s input circuit breaker on the rear panel of the UPS.
- 3.6.8.1.5 Remove the cover from the UPS.

**NOTE: The Input utility voltage is still present at the input filter board and at the terminal block. Use Caution.**

- 3.6.8.1.6 Disconnect the battery positive (Red) wire from the battery positive terminal and place a piece of black electrical tape over end of the battery positive (Red) wire.
- 3.6.8.1.7 The UPS is ready for maintenance.
- 3.6.8.1.8 Once the servicing of the UPS is complete, remove the black electrical tape from the end of the battery positive (Red) wire and reconnect the battery positive (Red) wire to the battery positive terminal.
- 3.6.8.1.9 Re-install the UPS cover.
- 3.6.8.1.10 Turn on the UPS’s input circuit breaker.
- 3.6.8.1.11 Turn the Maintenance Bypass Switch to the “INV” position. The UPS will transfer to the normal Bypass mode.



3.6.8.1.12 Press and hold the On Switch (on the front panel of the UPS) for approximately 3-seconds, then release. The audible alarm will sound 2-beeps. The UPS will perform its normal startup test. Once the startup is complete the UPS will be in the normal On-Line mode.

**NOTE:** If the Maintenance Bypass Procedure is not followed in the correct order and step-by-step the UPS and/or the connected equipment could be damaged.

## 4 Communication Port, EPO Port and Option Cards

The communication port on the UPS provides RS232 communications for remote monitoring and control.

### 4.1. RS232 Communication Port:

<b>Baud Rate</b>	<b>9600 bps</b>
<b>Data Length</b>	<b>8 bits</b>
<b>Stop Bit</b>	<b>1 bit</b>
<b>Parity</b>	<b>None</b>
<b>DB9 Pin 2</b>	<b>RS232 Tx</b>
<b>DB9 Pin 3</b>	<b>RS232 Rx</b>
<b>DB9 Pin 5</b>	<b>Ground</b>

### 4.2. EPO (Emergency Power Off) Port

Connect one end of a two-wire cable to the EPO port and the other end of the two-wire cable to an EPO switch, and then short pin1 to pin2 for approximately 1.0-second to shutdown the UPS in the AC or the Battery mode. The LCD display will display EPO and Line OFF every 6-seconds. The UPS must be turned off and then turned back on again to restart the UPS. Connecting to the EPO port is optional the UPS system operates properly without this connection.

#### AC Mode Operation:

While the UPS is in the normal AC mode apply the short to pin1 and pin2 for approximately 1.0-second. The UPS shuts down, the fans will still be on. In approximately 1-minute the fans will reduce speed.

To restart the UPS: Press the Off switch on the front panel for 2-beeps then release. Turn the UPS's input circuit breaker (on the rear panel) to the Off position. Wait for approximately 1-minute (until the fans turn off) then turn the input circuit breaker to the On position. The UPS will be in the Bypass mode. Press the On switch on the front panel for 2-beeps to turn the UPS on.

#### DC Mode Operation:

While the UPS is in the DC mode apply the short to pin1 and pin2 for approximately 1.0-second. The UPS shuts down, the fans will still be on. In approximately 1-minute the fans will reduce speed.

To restart the UPS once the utility power returns: Press the Off switch on the front panel for 2-beeps then release. Turn the UPS's input circuit breaker (on the rear panel) to the Off position. Wait for approximately 1-minute (until the fans turn off) then turn the input circuit breaker to the On position. The UPS will be in the Bypass mode. Press the On switch on the front panel for 2-beeps to turn the UPS on.

### 4.3. Option Cards

The optional interfaces cards are ED6/10KVA Programmable Relay Card (Dry Contact Relay) and the SNMP card. When the option cards are used in conjunction with RS232 communications port on the rear panel, the shutdown command from the EPO port will get the highest priority for the control command, then the RS232 port, then the SNMP card, and then the ED6/10KVA Programmable Relay card gets the lowest priority. Also there is ENV PROBE for environmental monitoring.

## 5 Power Monitoring Software

The SentryPlus software that comes with the UPS is compatible with many operating systems such as Windows NT/2000/XP/2003, Red Hat Linux, Fedora Linux, SuSE Linux, and FreeBSD.

### 5.1. Hardware Installation

- 5.1.1 Connect one end of the RS232 cable to the UPS communication port.
- 5.1.2 Connect the other end of the cable to the RS232 port on the computer.

### 5.2. Software Installation



- 5.2.1 Refer to the software user's manual on the software CD.

## 6 Troubleshooting Guide

If the UPS malfunctions, check the followings:

- Is the wiring of the input and the output correct?
- Is the input voltage within the acceptable window of the UPS?

If items a. and b. above are correct then proceed with the following chart. If the problem persists, see Obtaining Service.

Situation	Check Items	Solution
UPS Red Fault LED lights up	Check the error code shown on the LCD screen  1. Er05,  &  2. Er06, Er10, Er12, Er28 &  3. EPO 4. Er11, Er33 5. Er14 6. Er16, Er27 7. Er21 8. other error code	1. Check to see if the battery connection is properly done, then re-charge the batteries for 8-hours to see whether the UPS will backup normally; call for service. 2. Remove some of the load from the UPS output. Check the Input power cord. 3. Remove the short circuit at the EPO terminal. 4. Remove all objects that block the ventilation holes. 5. Check the fans on rear panel. 6. All of parameters except the ID number in the parallel UPS must be same. 7. Reconnect the RJ-45 wire or set a UPS with ID=1. 8. Call for Service.
UPS fails to offer battery backup or its runtime is too short.	The batteries maybe weak or at the end of useful service life.	Charge the batteries for 8-hours, then retest. If the runtime is still less than expected, the batteries need to be replaced. Contact your local distributor.
The UPS is in the Bypass or the On-Line mode there are no Error codes or faults and there is no output voltage at the terminal blocks.	Thermal Circuit Breaker CB3 has been tripped.	Turn off the UPS. Turn the Input circuit breaker on the rear panel to the Off position. Ensure the Maintenance Bypass Switch is in the "INV" position. Remove the two retaining screws from CB3's cover plate. Reset the Thermal Circuit Breaker CB3.
UPS locks itself and it cannot be turned off.	To unlock the UPS press the OFF switch for 5-seconds and the audible alarm will sound 2-beeps. Turn Off the input circuit breaker of the UPS.	The UPS should be unlocked, but the original problem may not be resolved. Call for Service.

## 7 Replacing the Batteries

**(QUALIFIED SERVICE PERSONNEL ONLY)**

Please read all of the **WARNINGS** and **CAUTIONS** before attempting to service the batteries.

**WARNING:** This Uninterruptible Power Supply contains potentially hazardous voltages. Do not attempt to disassemble the UPS system beyond the battery replacement procedure. This UPS system contains no user serviceable parts. Maintenance and Battery replacement must be performed by **QUALIFIED SERVICE PERSONNEL ONLY**.

**CAUTION:** Do not open or mutilate batteries. Released electrolyte is harmful to the skin and eyes and may be toxic.

**CAUTION:** Do not dispose of batteries in a fire. The batteries may explode.

**CAUTION:** The batteries in this UPS are recyclable. Dispose of the batteries properly. The batteries contain lead and pose a hazard to the environment and human health if not disposed of properly. Refer to local codes for proper disposal requirements or return the battery to the supplier.

**CAUTION:** The battery system voltage is 240VDC and can present a risk of electrical shock. These batteries produce sufficient current to burn wire or tools very rapidly, producing molten metal. Observe these precautions when replacing the batteries:

- Remove watches, rings, or other metal objects.
- Use hand tools with insulated handles.
- Wear protective eye gear (goggles), rubber gloves and boots.
- Do not lay tools or other metal parts on top of batteries.
- Disconnect the charging source prior to connecting or disconnecting the battery terminals.
- Determine if the battery is inadvertently grounded. If the battery is, remove the source of the grounding. Contact with any part of a grounded battery can result in an electrical shock. The likelihood of such shock will be reduced, if such grounds are removed during installation and maintenance.

**CAUTION:** Replace the batteries with the same number and type as originally installed. These batteries have pressure-operated vents. These batteries contain sealed non-spillable maintenance-free lead acid batteries.

## 7.1. Battery Replacement Procedure (QUALIFIED SERVICE PERSONNEL ONLY)

This UPS system does not have Hot-swappable batteries. The UPS system must be turned Off to perform the Battery Replacement.

- 7.1.1 Turn Off all the equipment that is connected to the UPS.
- 7.1.2 Press the Off switch on the front panel of the UPS for approximately 5-seconds.
- 7.1.3 Turn the input circuit breaker on the rear panel of the UPS to the Off position.
- 7.1.4 Turn the utility power circuit breaker at the service panel to the Off position.
- 7.1.5 Disconnect all of the communications and network cables from the rear panel of the UPS.

**NOTE:** If you are using an External Battery Pack, turn ALL of the DC circuit breaker (s) on the rear panel of the Battery Pack (s) to the Off position. Disconnect the all of the battery cables from the UPS and the Battery Pack (s) rear panels.

- 7.1.6 Remove the retaining screws for the top cover on the rear panel of the UPS.
- 7.1.7 Slide the top cover towards the rear of the UPS and lift up to remove the top cover and set aside. (FIG. 1)
- 7.1.8 Remove the retaining screws for the side panels on the rear panel of the UPS.
- 7.1.9 Slide the side panels towards the rear of the UPS and lift up to remove the side panels and set aside. (FIG. 2)

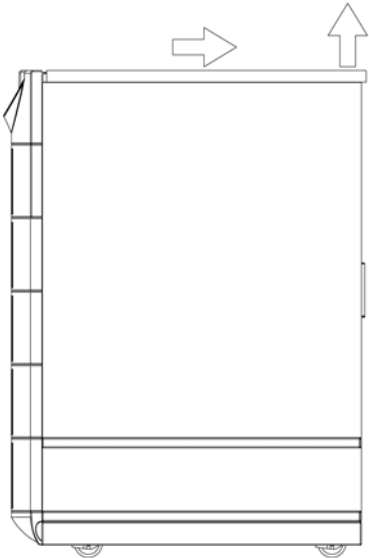

FIG. 1

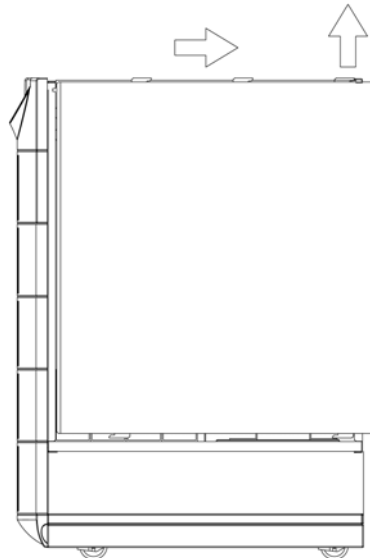

FIG. 2

- 7.1.10 Looking from the front of the UPS on the right-hand side (FIG. 3), disconnect the battery positive (Red) wire. Place a piece of electrical tape over the end of battery positive (Red) wire.

- 7.1.11 Disconnect battery jumper "A" and place a piece of electrical tape over the end of battery jumper wire "A".

- 7.1.12 Disconnect all of the battery jumper wires.

- 7.1.13 Remove the battery-retaining bracket retaining screws.

- 7.1.14 Remove the battery-retaining brackets.

- 7.1.15 Remove the defective batteries and set aside.

- 7.1.16 Install the new batteries in the same position as the original batteries.

- 7.1.17 Re-install the battery-retaining brackets.

**NOTE: DO NOT** pinch the battery wires between the batteries and the battery-retaining brackets.

- 7.1.18 Re-install the battery-retaining bracket retaining screws.

- 7.1.19 Observe polarity. Reconnect all of the battery jumper wires.

- 7.1.20 Remove the piece of electrical tape from the end of battery jumper wire "A". Observe polarity. Reconnect battery jumper wire "A".

**NOTE: DO NOT** Reconnect the battery positive (Red) wire at this time.

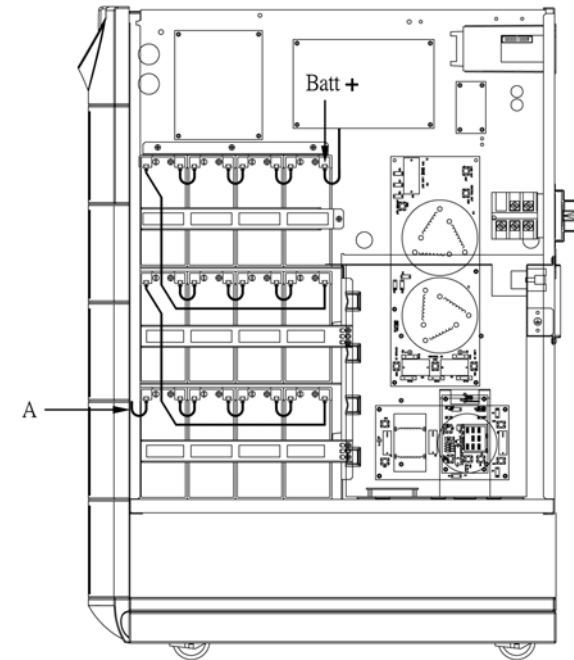

A - This battery jumper wire goes to the left side of the UPS, bottom bank of batteries, the right hand battery, the positive battery terminal.

FIG. 3

- 7.1.21 Looking from the front of the UPS on the left-hand side (FIG. 4), disconnect the battery negative (Black) wire. Place a piece of electrical tape over the end of battery negative (Black) wire.
  - 7.1.22 Disconnect battery jumper "A" and place a piece of electrical tape over the end of battery jumper wire "A".
  - 7.1.23 Disconnect all of the battery jumper wires.
  - 7.1.24 Remove the battery-retaining bracket retaining screws.
  - 7.1.25 Remove the battery-retaining brackets.
  - 7.1.26 Remove the defective batteries and set aside.
  - 7.1.27 Install the new batteries in the same position as the original batteries.
  - 7.1.28 Re-install the battery-retaining brackets.
- NOTE: DO NOT** pinch the battery wires between the batteries and the battery-retaining brackets.
- 7.1.29 Re-install the battery-retaining bracket retaining screws.
  - 7.1.30 Observe polarity. Reconnect all of the battery jumper wires.
  - 7.1.31 Remove the piece of electrical tape from the end of battery jumper wire "A". Observe polarity. Reconnect battery jumper wire "A".

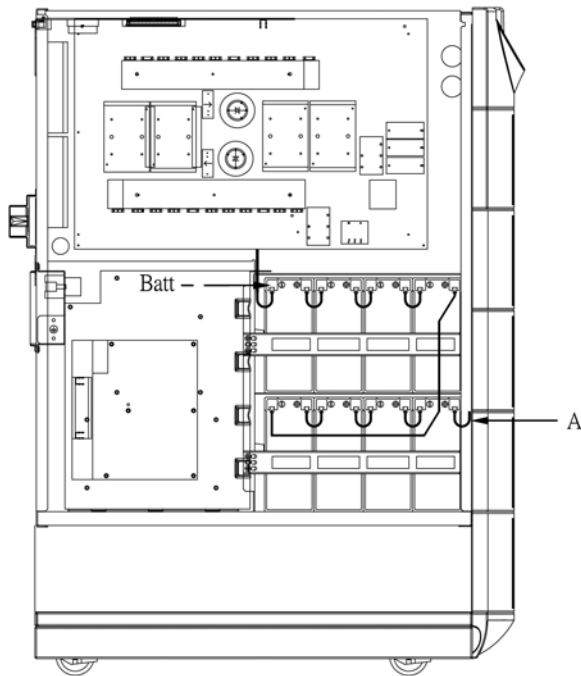

A - This battery jumper wire goes to the right side of the UPS, bottom bank of batteries, the left hand battery, the negative battery terminal.

**FIG. 4**

- 7.1.32 Back to the right-hand side of the UPS (FIG. 3), remove the piece of electrical tape from the end of battery positive (Red) wire. Observe polarity. Reconnect the battery positive (Red) wire.
- NOTE:** Some sparking might occur, this is normal.
- 7.1.33 Re-install the side panels and the retaining screws. (FIG. 2)
  - 7.1.34 Re-install the top cover and the retaining screws. (FIG. 1)
  - 7.1.35 Reconnect all of the communications and network cables.
- NOTE:** If you are using an External Battery Pack, reconnect the all of the battery cables to the UPS and the Battery Pack (s) rear panels. Turn ALL of the DC circuit breaker (s) on the rear panel of the Battery Pack (s) to the On position.
- 7.1.36 Turn the utility power circuit breaker at the service panel to the On position.
  - 7.1.37 Turn the input circuit breaker on the rear panel of the UPS to the On position.
  - 7.1.38 Turn On the equipment that is connected to the UPS.
  - 7.1.39 Press and hold the On Switch (on the front panel) for approximately 3-seconds, then release.
  - 7.1.40 The UPS system is now ready for the normal operation.
  - 7.1.41 Properly dispose of the old batteries at an appropriate recycling facility or return them to the supplier in the packing material for the new batteries.

## 8 Specifications

MODEL	ED1000T (Has an internal Galvanic isolation step-down transformer)	ED1020T
Topology	Double Conversion On-Line, True Sine Wave	
Maximum Power Capacity	10000VA/7000Watts	
<b>INPUT</b>		
Number of Phases	Single (1Ø 2W +G)	
Nominal Voltage	208VAC	
Acceptable Input Voltage	0 - 300VAC	
Voltage Range	160* - 280VAC	
Power Factor Correction	>98% at Full Load	
Frequency Limits	50/60Hz +/-5Hz autosensing	
Low Voltage Transfer Point	160V resets to utility power at 175V or higher	
High Voltage Transfer Point	280V resets to utility power at 265V or lower	
Protection	Re-settable Circuit Breaker	
<b>OUTPUT</b>		
Waveform Type	True Sine Wave	
Nominal Voltage	120VAC and 208/240VAC	208/240VAC
Voltage Regulation	+/-2% (until Low Battery Warning)	
Frequency	50/60Hz +/-0.2Hz (unless synchronized to utility)	
Voltage T.H.D.	≤3% (Linear load)	
Dynamic Response	+/-5% @ 100% Load change in 100ms	
Transfer Time	0ms	
Slew Rate	≤1Hz / second	
Efficiency (Line Mode)	>87% (Full Load)	
Crest Factor	3 : 1	
Overload Capacity	≥105% - ≤155% for 160 seconds ≥156% shutdown immediately	
Protection	Over-Current, Short-Circuit and Latching Shutdown	
<b>SURGE PROTECTION AND FILTERING</b>		
Surge Energy Rating	1050 J	
Surge Energy Capability	6500 Amps total	
Surge voltage let-through (as a percentage of an applied ANSI C62.41 Cat. A +/-6KV)	<5%	
Noise Filter	Normal and common mode EMI/RFI suppression	
Audible Noise at 1 m (3 ft.)	<50dB	

\* 160 – 280VAC at loads ≤50% of the rated capacity

\* 175 – 280VAC at loads ≤75% of the rated capacity

\* 180 – 280VAC at loads ≥75% of the rated capacity

<b>BATTERY</b>		
Type	Sealed, Non-Spillable, Maintenance Free, Valve Regulated, Lead Acid	
Typical Recharge Time	8-hours from total discharge	
Typical Battery Life	3 - 5 years, depending on the number of charge and discharge cycles, and ambient temperature	
System Voltage	240VDC	
Quantity/Rating	20-12V9Ah	
Battery part numbers	Yuasa – NPW45-12 CSB – HR 1234W F2 Panasonic – LC-R129	
Runtime (full/half load)	5/15 minutes	
<b>ENVIRONMENTAL</b>		
Operating Temp (max)	0 to 40°C (+32 to +104°F) ≤2000m (≤+6700 ft) 0 to 35°C (+32 to +95°F) at 3000m (+10,000 ft)	
Storage Temp	-15 to +45°C (+5 to +113°F)	
Operating/Storage Humidity	30 - 90% Non-Condensing	
Storage Elevation	0 to 15,000m (0 to +50,000 ft)	
<b>PHYSICAL</b>		
Size - Net D x W x H	25.4 x 11.4 x 34.7" 645 x 290 x 881mm	25.4 x 11.4 x 29.4" 645 x 290 x 748mm
Weight - Net	374 lbs 170 kgs	264 lbs 120 kgs
Size – Shipping D x W x H	31.9 x 18.4 x 43.7" 810 x 468 x 1110mm	31.9 x 18.4 x 38.5" 810 x 468 x 977mm
Weight - Shipping	412 lbs 187 kgs	302 lbs 137 kgs
<b>REGULATORY COMPLIANCE</b>		
Safety and Approvals	UL 1778, cUL (CSA 22.2 no. 107.1), CE (EN62040-1-1)	
EMC	CE (EN62040-2, EN61000-3-2, EN61000-3-3), FCC Class A	

## 9 Obtaining Service

- 9.1.1 Use the troubleshooting section to eliminate obvious causes.
- 9.1.2 Verify there are no circuit breakers tripped. A tripped circuit breaker is the most common problem. Call your dealer for assistance. If you cannot reach your dealer, or if they cannot resolve the problem call or fax MINUTEMAN Technical Support at the following numbers; Voice phone (972) 446-7363, FAX line (972) 446-9011 or visit our Web site at [www.minutemanups.com](http://www.minutemanups.com) the "Discussion Board". Please have the following information available BEFORE calling the Technical Support Department.
  - a. Your name and address.
  - b. Where and when the unit was purchased.
  - c. All of the model information about your unit.
  - d. Any information on the failure.
  - e. A technician will ask you for the above information and, if possible, help solve your problem over the phone. In the event that the unit requires factory service, the technician will issue you a Return Material Authorization Number (RMA #).
  - f. If the unit is under warranty, the repairs will be done at no charge. If not, there will be a charge for repair.
- 9.1.3 Pack the unit in its original packaging. If the original packaging is no longer available, ask the Technical Support Technician about obtaining a new set. It is important to pack the unit properly in order to avoid damage in transit. Never use Styrofoam beads for a packing material.
  - a. Include a letter with your name, address, daytime phone number, RMA number, a copy of your original sales receipt, and a brief description of the problem.
  - b. Mark the RMA # on the outside of all packages. The factory cannot accept any package without the RMA # marked on the outside.
- 9.1.4 Return the unit by insured, prepaid carrier to:

Para Systems Inc.  
MINUTEMAN UPS  
1455 LeMay Drive  
Carrollton, TX 75007  
ATTN: RMA # \_\_\_\_\_

## 10 Limited Product Warranty

Para Systems, Inc. (Para Systems) warrants this equipment, when properly applied and operated within specified conditions, against faulty materials or workmanship for a period of three years from the date of purchase. For equipment sites within the United States and Canada, this warranty covers repair or replacement of defective equipment at the discretion of Para Systems. Repair will be from the nearest authorized service center. Replacement parts and warranty labor will be borne by Para Systems. For equipment located outside of the United States and Canada, Para Systems only covers faulty parts. Para Systems products repaired or replaced pursuant to this warranty shall be warranted for the un-expired portion of the warranty applying to the original product. This warranty applies only to the original purchaser who must have properly registered the product within 10 days of purchase.

The warranty shall be void if (a) the equipment is damaged by the customer, is improperly used, is subjected to an adverse operating environment, or is operated outside the limits of its electrical specifications; (b) the equipment is repaired or modified by anyone other than Para Systems or Para Systems-approved personnel; or (c) has been used in a manner contrary to the product's User's Manual or other written instructions.

Any technical advice furnished before or after delivery in regard to use or application of Para Systems' equipment is furnished without charge and on the basis that it represents Para Systems' best judgment under the circumstances, but it is used at the recipient's sole risk.

Except as provided herein, Para Systems makes no warranties, expressed or implied, including warranties of merchantability and fitness for a particular purpose. Some states do not permit limitation of implied warranties; therefore, the aforesaid limitation(s) may not apply to the purchaser.

EXCEPT AS PROVIDED ABOVE, IN NO EVENT WILL PARA SYSTEMS BE LIABLE FOR DIRECT, INDIRECT, SPECIAL, INCIDENTAL, OR CONSEQUENTIAL DAMAGES ARISING OUT OF THE USE OF THIS PRODUCT, EVEN IF ADVISED OF THE POSSIBILITY OF SUCH DAMAGE. Specifically, Para Systems is not liable for any costs, such as lost profits or revenue, loss of equipment, loss of use of equipment, loss of software, loss of data, cost of substitutes, claims by third parties, or otherwise. The sole and exclusive remedy for breach of any warranty, expressed or implied, concerning Para Systems' products and the only obligation of Para Systems hereunder, shall be the repair or replacement of defective equipment, components, or parts; or, at Para Systems' option, refund of the purchase price or substitution with an equivalent replacement product. This warranty gives you specific legal rights and you may have other rights, which vary from state to state.

## 11 Declaration of Conformity

Notes:

Application of Council Directive(s): 89/336/EEC, 73/23/EEC

Standard(s) to which Conformity is declared: EN62040-1-1, EN62040-2, EN61000-3-2, EN61000-3-3, UL 1778, cUL (CSA 22.2 no. 107.1)

Manufacturer's Name: Para Systems, Inc. (MINUTEMAN UPS)

Manufacturer's Address: 1455 LeMay Drive  
Carrollton, Texas 75007 USA

Type of Equipment: Uninterruptible Power Supplies (UPS)

Model No: ED10000T, ED10200T

Year of Manufacture: Beginning November 1, 2008

I, hereby declare that the equipment specified above conforms to the above Directive(s).

Robert Calhoun  
(Name)

Manager Engineering  
(Position)

Place: Carrollton, Texas, USA

Date: November 1, 2008